

HARRINGTON STORZ SPECIFICATION SHEET

HSFR40-60NH

All Aluminum

- **6" NH (NST) FEMALE RIGID** with Rocker Lugs
- **4" STORZ** with Storz-Lok

- **Hard Anodized 6061-T6 Storz & NH**
- **250 psi working pressure**

Specify **HARRINGTON STORZ: HSFR40-60NH**

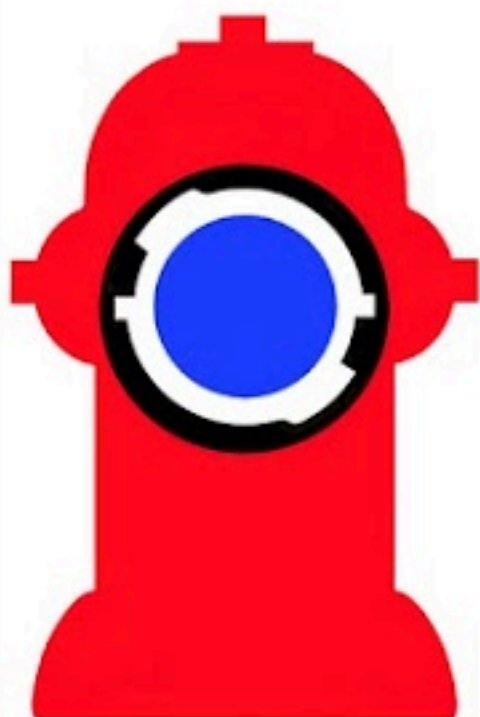
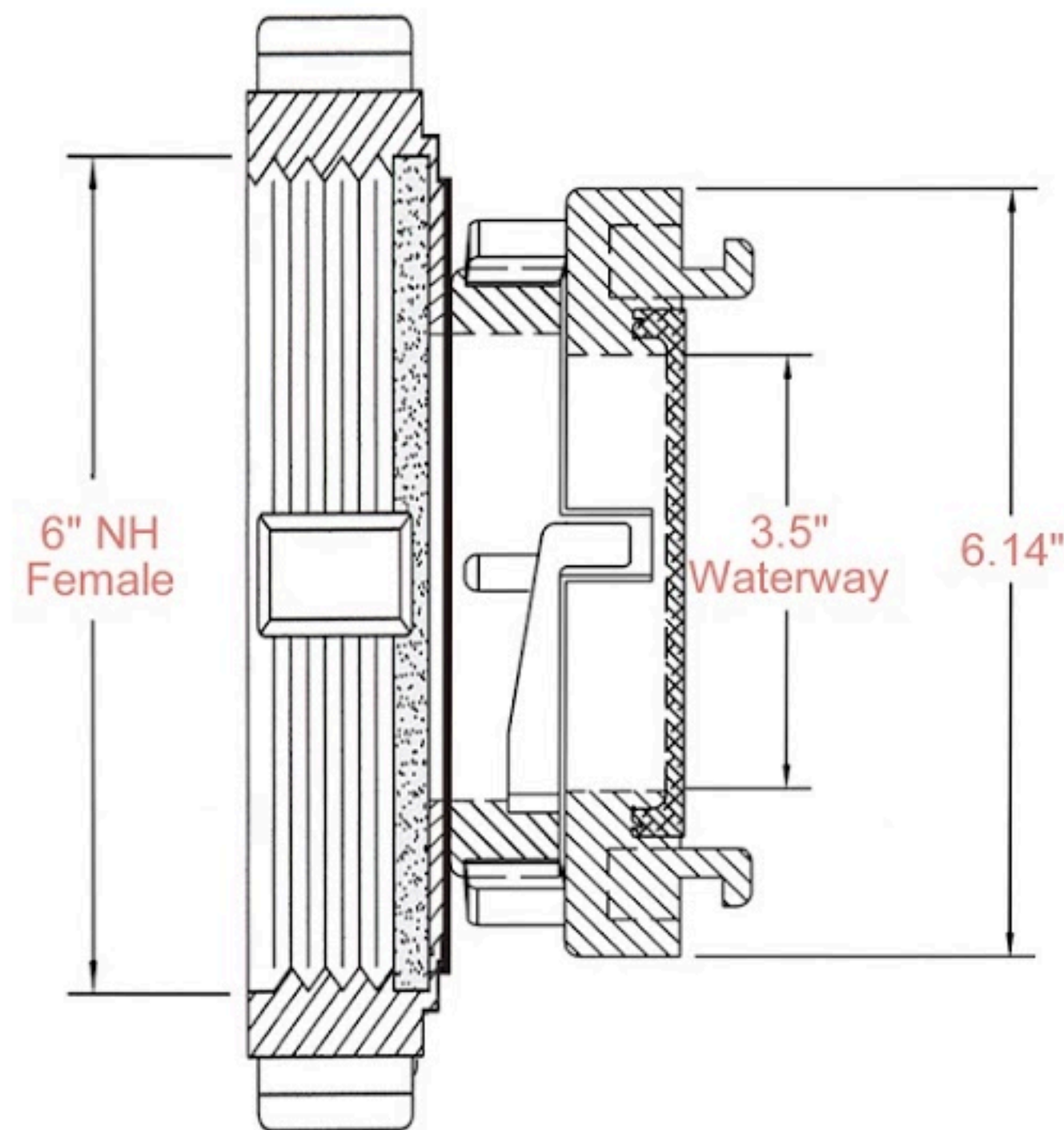

Harrington, Inc.
2630 W. 21st St.
Erie, PA 16506

Ph. 800-553-0078
daveh@harrinc.com



HSFR40-60NH

6" NH Female Rigid x 4" Storz with Storz-Lok

Date: 01/25/21

Weight: 4.3 lbs.

Specification / Data Sheet

Not to scale

DB: DTH

Sheet 1 of 1

NH