

HARRINGTON STORZ SPECIFICATION SHEET

HSMR40-50NH

All Aluminum

- **5" NH (NST) MALE**
- **4" STORZ** with Storz-Lok

- **Hard Anodized 6061-T6 Storz & NH**
- **250 psi working pressure**

Specify **HARRINGTON STORZ: HSMR40-50NH**

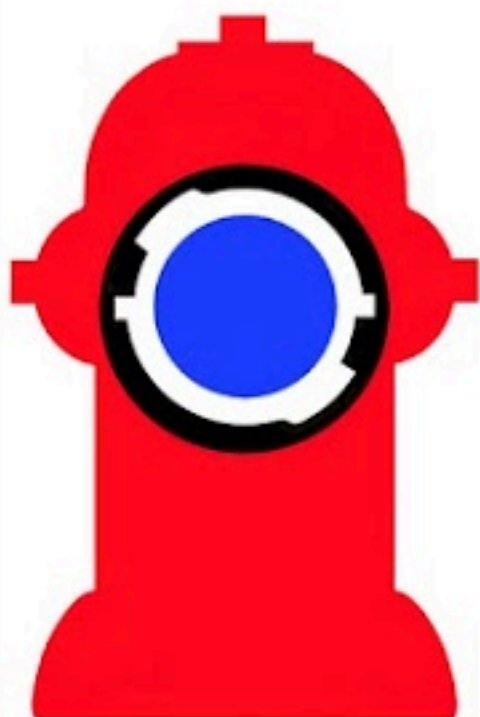
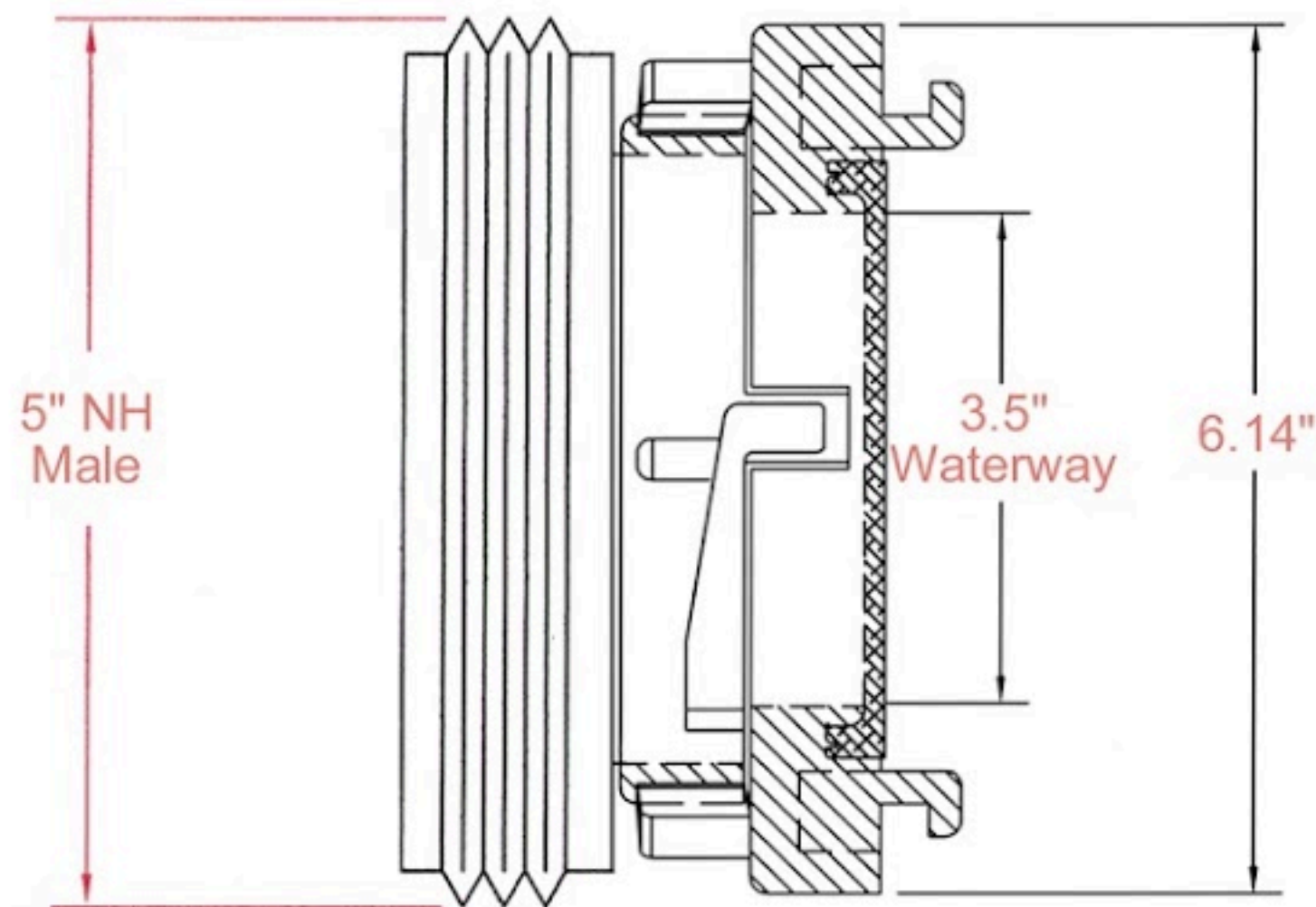

Harrington, Inc.
2630 W. 21st St.
Erie, PA 16506

Ph. 800-553-0078
daveh@harrinc.com



HSMR40-50NH

5" NH Male x 4" Storz with Storz-Lok

Date: 01/25/21

Weight: 4.2 lbs.

Specification / Data Sheet

Not to scale

DB: DTH

Sheet 1 of 1

NH